

KEMPER[®] echo™



More for less.

You don't need a fat wallet to get inviting style and serious function. That's because Kemper® Echo™ gives you more for less.

More storage-stretching organizers, less wasted space. Our cabinets push capacity to the max, making your kitchen seem and work bigger.

More personality, less ho-hum. From the overall look to the details like glass and hardware, you can easily tailor Echo to suit your taste and lifestyle.

More confidence, less doubt. Echo cabinets are precision-made of quality materials and backed by Kemper's Limited Lifetime Warranty. They're also easy to plan with, order and install. (But if you want help, we're here to lend a hand.)

Whatever the size of your room, your budget, or your wish list, Echo gives you more ways to get generous style and function at a price you can afford.

Kemper Echo: Get used to more.

kitchen spaces

4

other spaces

Bath 24

Utility 28

details

Door Styles 30

Specialty Glass 36

Hardware 37

Construction 38

Spec Section 40

contents



1. DOUBLE WASTEBASKET

2. TOEKICK DRAWER MODIFICATION

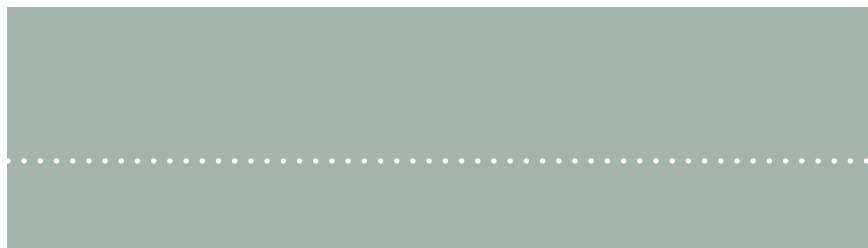



WOLCOTT maple
limestone

..... more real life, less pretentious

comfortable kitchen



CROSBY cherry
dark ale

more living, less stuffy.....



1. GLASS INSERTS

2. FURNITURE DRAWERS



1. BASE WASTEBASKET

2. WALL TOP HINGE CABINETS

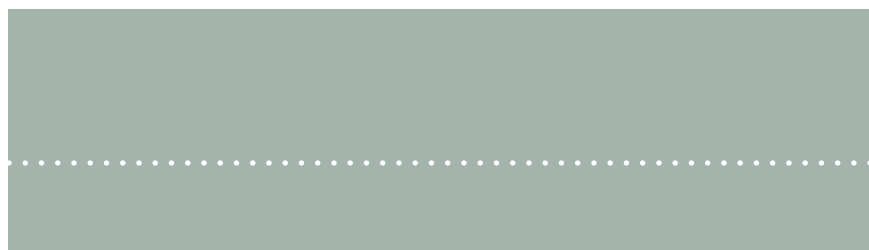

exceptional kitchen



LORETTO cherry sandstone

..... more pizzazz, less vanilla

1. ART CORBEL

2. WALL MESSAGE CENTER



traditional kitchen



MORIARTY maple
Cabinets in dark ale.
Island in alabaster with brown sugar glaze.

11

..... more charm, less chore



1. BASE EASY REACH

2. OPEN CABINET WITH GLASS SHELVES

3. LIGHT BAFFLE MOULDING WITH ART CORBEL

4. COUNTRY BASE SINK WITH ANGLED FURNITURE
TOEKICK VALANCE

more you, less me-too

country-fresh kitchen



TEAGUE PureStyle™ Laminate
alabaster

1. EASY REACH WALL CABINET

2. TWO DRAWER BASE WITH SLIDING SHELF





15

MARIMAC maple
Cabinets in sandstone with brown sugar glaze.
Island in dark ale with brown sugar glaze.

..... more built-in benefits, less wasted space

colorful kitchen



SULTAN oak
barley



1. LIGHT RAIL UNDER-CABINET MOULDING

3. TULIP FOOT

2. SUPER LAZY SUSAN

4. SINK BASE SUPERCABINET™

..... more choices, less compromise



EKSTEN maple and cherry
Cabinets in maple limestone with brown sugar glaze.
Island in cherry amber suede with brown sugar glaze.

more convenience, less stress



1. SLIDING SHELF BASE

2. MISSION ROSETTE





1



2



3

1. UTILITY STORAGE CABINET

3. WINE CUBBIES

2. CUTLERY DRAWER ORGANIZER

more doing, less doing without

contemporary kitchen



CROSBY PureStyle™ Laminate
alabaster



22

HYDE cherry and maple
Cabinets in cherry amber suede.
Island in maple alabaster with barn wood glaze.

more of what you want, less of what you don't



1. BASE PANTRY PULLOUT

2. BASE TRAY DIVIDER



23





24

EKSTEN cherry
leather

more soaking it up, less getting soaked



1. LINEN CLOSET WITH REMOVABLE HAMPER

2. BEADED BASEBOARD MOULDING



1

25



2



1. FURNITURE DRAWER

2. LILLE FOOT

more pleasure, less hassle

casual bath



1. UTILITY CABINET WITH SLIDING SHELVES

2. METRO ISLAND COLUMN

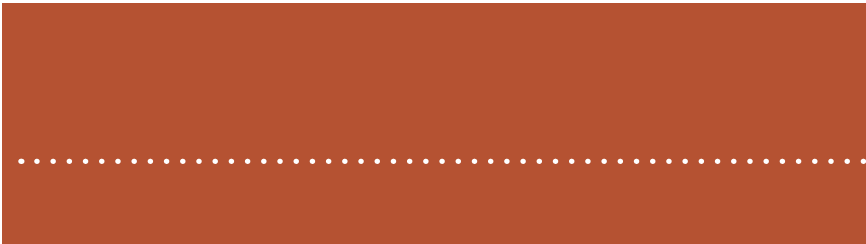



29

TARVER oak
dark ale

..... more me time, less chore time

maple styles & finishes



Antrim ◦

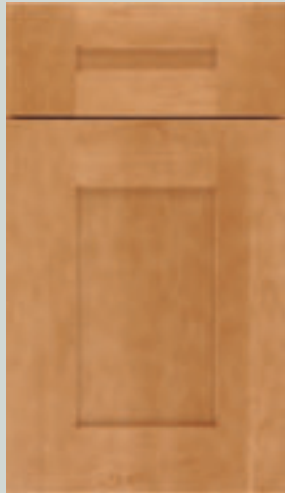

Crosby •

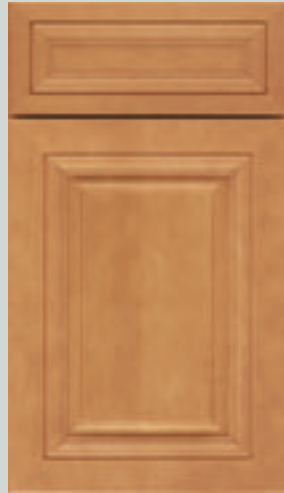

Eksten •



Hyde ◦



Loretto •



Marimac •

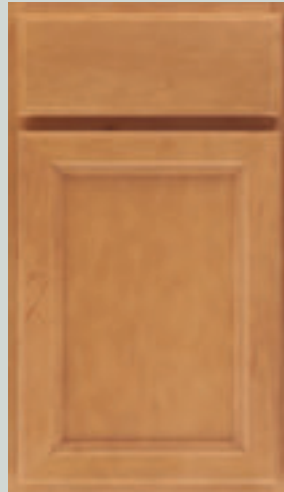

Moriarty ◦



Napa ◦



Sultan •

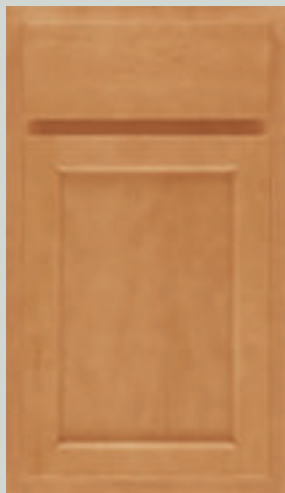

Tarver ◦

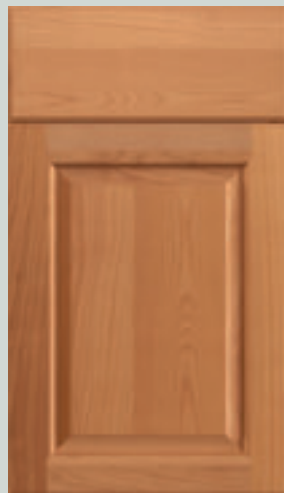

Tolono •



Wolcott •

30

Maple is a close-grain, very hard, smooth-textured wood with a uniform appearance. Its color can range from creamy white to pale, reddish-brown. The wood can also have tiny "bird's eye" knots and mineral streaks.

maple

standard finishes

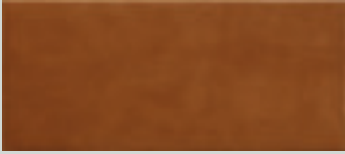

Amber Suede

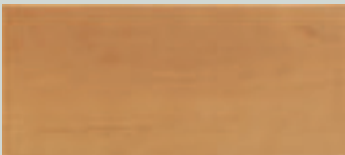

Barley

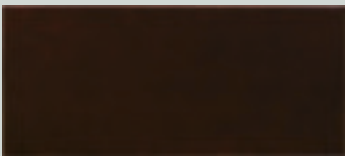

Dark Ale

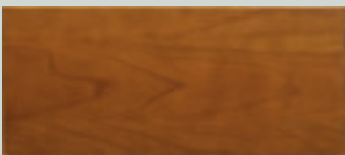

Leather



Natural

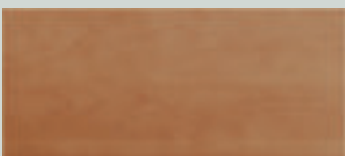

Sandstone

Unfinished also available

glazes*

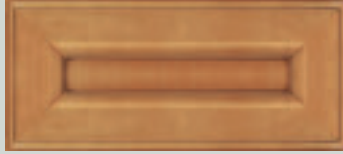

Barn Wood

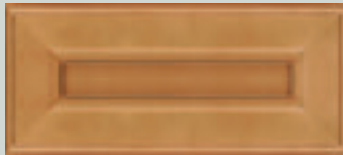

Brown Sugar

**Glazes available on all standard finishes*

premium opaque finishes

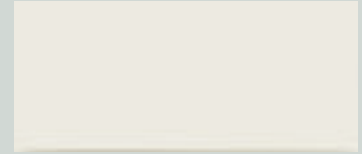

Alabaster

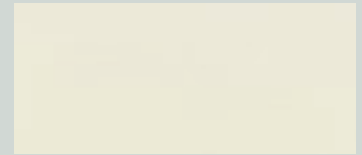

Brie

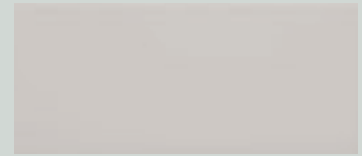

Limestone

glazes*



Barn Wood

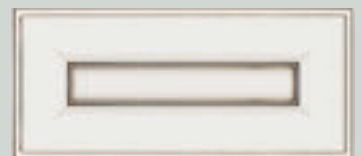

Brown Sugar

** Glazes are available on all standard and premium opaque finishes.*

cherry styles & finishes



Antrim ◦

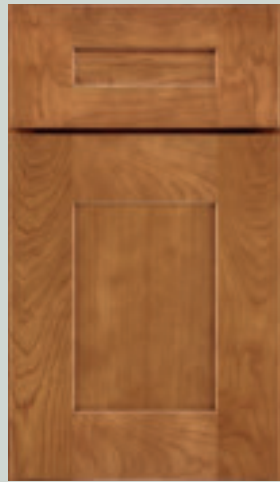

Crosby •

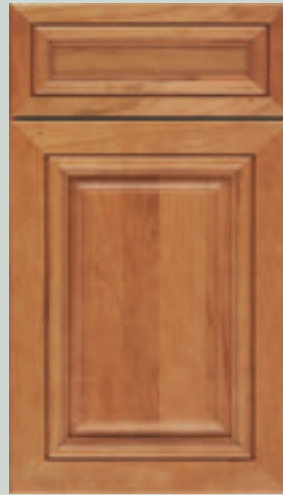

Eksten •

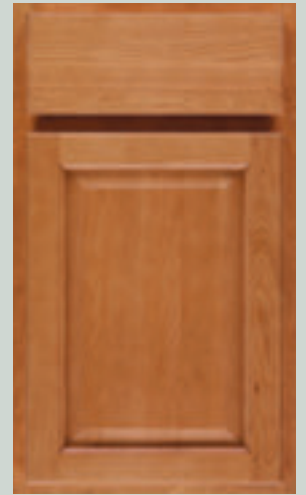

Hyde ◦



Loretto •

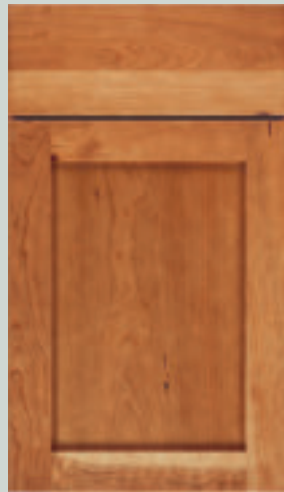

Marimac •

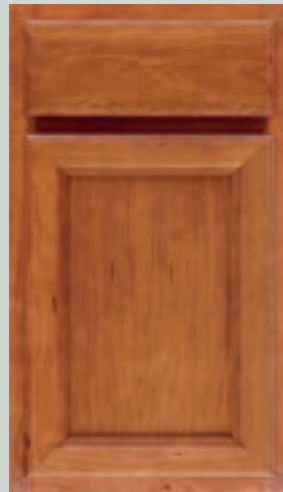

Moriarty ◦



Napa ◦



Sultan •

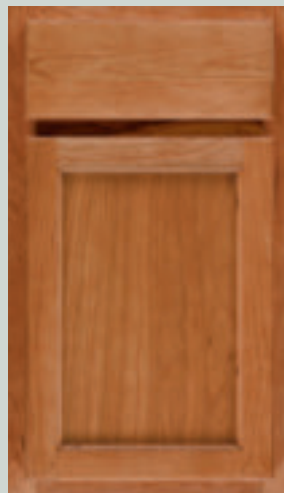

Tarver ◦

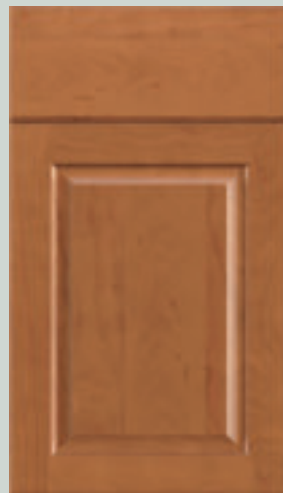

Tolono •



Wolcott •

Cherry is close-grained and has a very fine texture. The color can vary from tan-blonde to deep reddish brown, often getting darker and more rich as it ages.

cherry

standard finishes

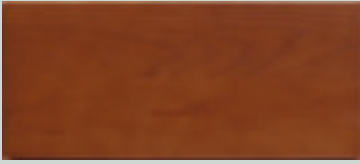

Amber Suede



Barley

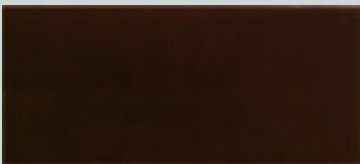

Dark Ale

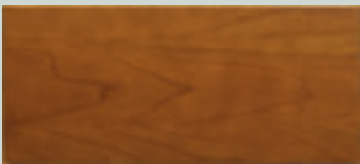

Leather

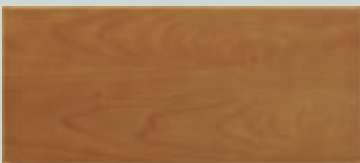

Sandstone

glazes*

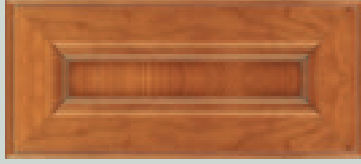

Barn Wood



Brown Sugar

** Glazes are available on all standard finishes.*

Unfinished also available

oak styles & finishes



Antrim ◦

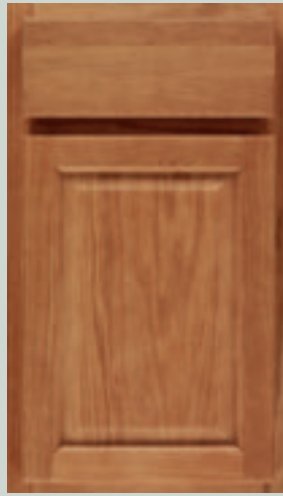

Hyde ◦

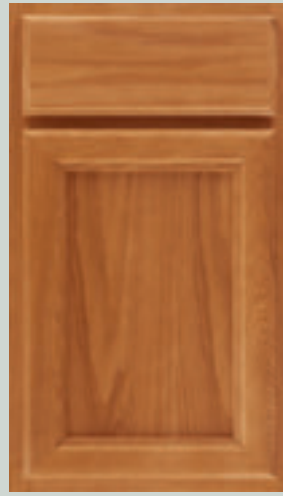

Moriarty ◦



Napa ◦



Sultan •



Tarver ◦

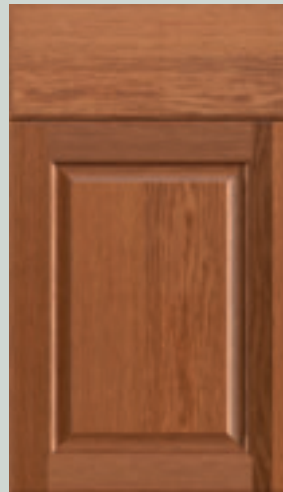

Tolono •

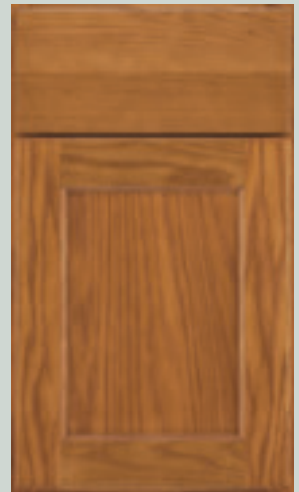

Wolcott •

Oak is open-grained and very strong and durable. It can range in color from salmon red to dark cinnamon. The wood can also exhibit random worm holes, mineral deposits, knots, and wild grain patterns.

oak

standard finishes



Amber Suede



Barley

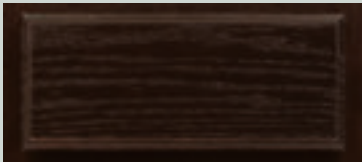

Dark Ale

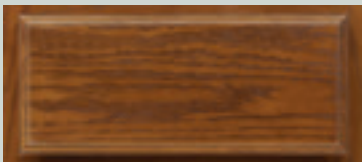

Leather



Natural

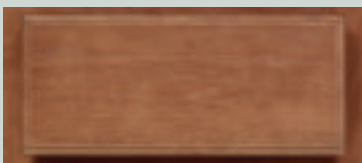

Sandstone

glazes*



Barn Wood

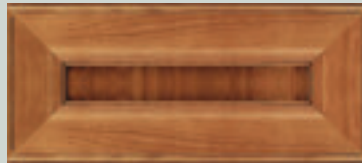

Brown Sugar

** Glazes are available on all standard finishes.*

Unfinished also available

PureStyle™ styles & finishes

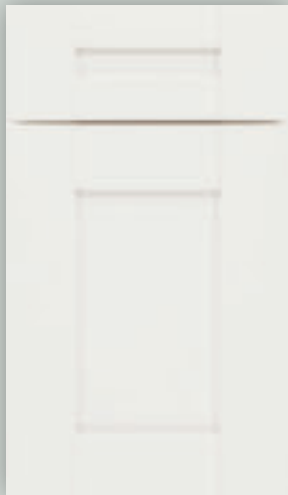

Crosby •

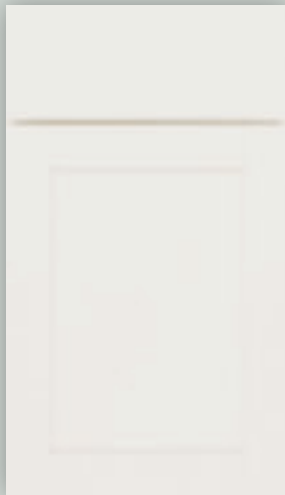

Marimac •

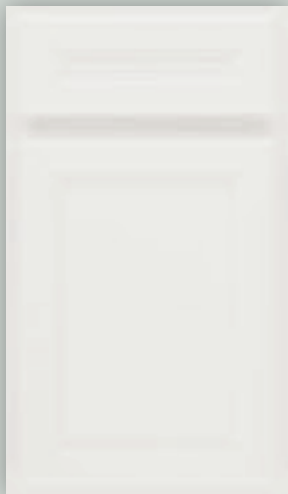

Moriarty ◦

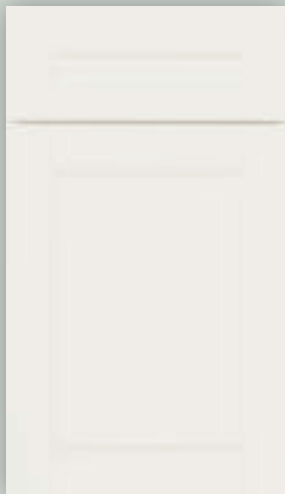

Teague •

standard finishes

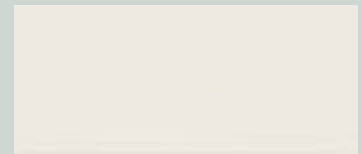

Alabaster

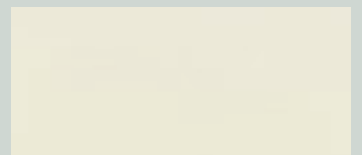

Brie

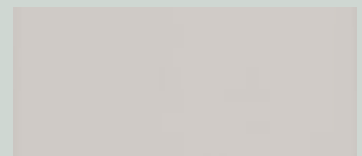

Limestone

• Full Overlay

◦ Partial Overlay

glass inserts

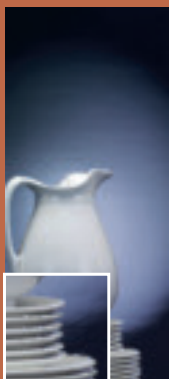

A

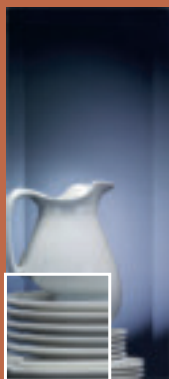

B

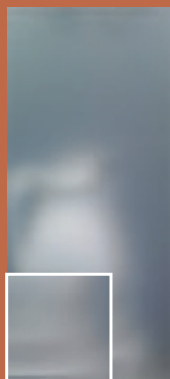

C

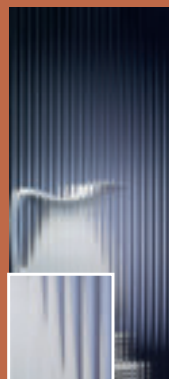

D

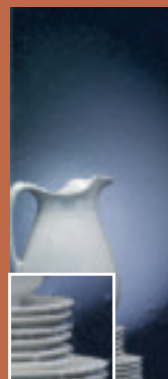

E

- A: ANTIQUE
- B: BEVEL
- C: FROST
- D: REEDED
- E: SEEDED

Clear also available



- | | | |
|------------|------------|-------------|
| A. KNOBH06 | G. KNOBH46 | M. KNOBH57 |
| B. KNOBH20 | H. KNOBH23 | N. KNOBH65 |
| C. KNOBH10 | I. KNOBH31 | O. KNOBH62 |
| D. KNOBH07 | J. KNOBH32 | P. KNOBH58 |
| E. KNOBH37 | K. PULLH51 | Q. WOODKNOB |
| F. KNOBH40 | L. KNOBH54 | |

knobs

- | | | |
|------------|-------------|----------------------|
| R. PULLH36 | Y. PULLH30 | FF. PULLH56 |
| S. PULLH11 | Z. PULLH52 | GG. PULLH61 |
| T. PULLH39 | AA. PULLH50 | HH. PULLH55 |
| U. PULLH41 | BB. PULLH60 | SMWOODPULL NOT SHOWN |
| V. PULLH38 | CC. PULLH59 | LGWOODPULL NOT SHOWN |
| W. PULLH08 | DD. PULLH63 | |
| X. PULLH53 | EE. PULLH64 | |

pulls



construction



standard cabinet

- 3/8" Furniture board end panels
- 1/2" Furniture board top and bottom
- 1/2" Plywood I-beam braces dadoed into face frame, end panels and back
- 3/8" Furniture board integrated back
- 3/4" Solid hardwood face frame
- Fully concealed, 6-way adjustable hinge
- Cabinet interior laminated natural maple or white

standard drawer

- 3/4 extension, side-mounted, epoxy-coated guides
- 1/2" laminated furniture board sides; 3/8" bottom



cabinet box options



UPGRADE 1 ALL PLYWOOD WITH LAMINATE ENDS (APL)

- All standard features. Replaces standard cabinet construction with plywood
- 3/8" Plywood end panels and back
- 1/2" Plywood top, bottom, and I-beam braces
- Exterior end panels laminated to match the selected finish



UPGRADE 2 ALL PLYWOOD WITH FINISHED ENDS (APF)

- All standard features. Replaces standard cabinet construction with plywood
- 3/8" Plywood end panels and back
- 1/2" Plywood top, bottom, and I-beam braces
- Finished veneer exterior end panels to match the selected finish



UPGRADE 3 FURNITURE FINISHED PLYWOOD END PANELS (FPFB)

- All standard features. Replaces standard 3/8" end panels with 5/8" plywood
- Finished veneer exterior end panels to match the selected finish

smart stop™ upgrades



DRAWER UPGRADE SOLID WOOD DOVETAIL DRAWER WITH FULL EXTENSION GUIDE WITH SMART STOP™ (PG)

- Replaces 3/4 extension with full extension, undermount guides with Smart Stop™ and fast-clip removal system
- 4-sided, clear-coated, solid wood drawer box
- 3/4" * dovetail sides with 5.2mm laminated plywood bottom

*3/4" prior to processing; actual final dimensions may vary

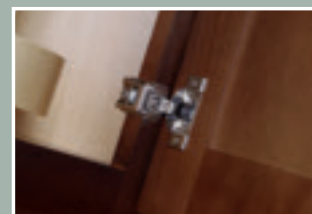

DOOR HINGE UPGRADE SMART STOP™ CABINET DOOR HINGE (INTGH)

- This innovative hinge provides a gentle, controlled self-closing feature that engages when the door nears the cabinet face frame.

construction



shelf options

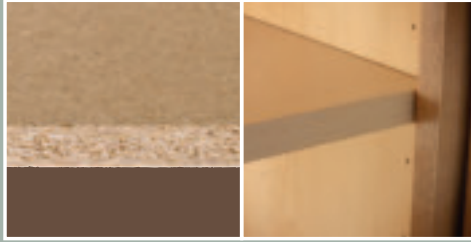

STANDARD FURNITURE BOARD SHELVES

- 3/4" adjustable furniture board shelving

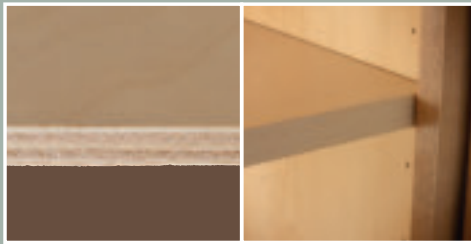

UPGRADE PLYWOOD SHELVES

- All standard features. Replaces standard shelves with laminated plywood shelves
- Must upgrade to all plywood construction (APL or APF)



roll tray options

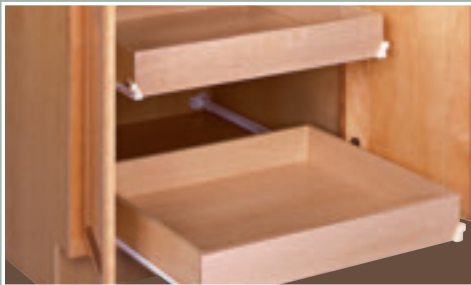

STANDARD FURNITURE BOARD ROLL TRAYS

- 3/4 extension, side-mount guides
- 3/8" natural maple laminated furniture board bottom
- 1/2" natural maple laminated furniture board sides



UPGRADE SOLID WOOD DOVETAIL ROLL TRAYS WITH SMART STOP™ (SP)

- Replaces 3/4 extension guides with Smart Stop™ full extension guides
- 4-sided, clear-coated, solid wood
- 3/4"* dovetail sides with 5.2mm laminated plywood bottom

*3/4" prior to processing; actual final dimensions may vary



Kitchen Cabinet Manufacturers Association



Environmental Stewardship Program
All products impact the environment.
For ESP program criteria, visit greencabinetsource.org



CABINET NOMENCLATURE

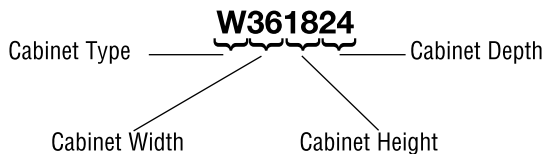

The cabinets listed below, and in the following pages, represent a sampling of our most popular cabinets. See your kitchen and bath designer for our full-line of cabinets and their specifications.

Here are some things to keep in mind when choosing your cabinets:

For Single Door Cabinets, specify L or R hinging.

Standard Depths and Heights (unless otherwise noted):

Wall Cabinet Depth is 12".

Base Cabinet Depth is 24", Height 34 1/2".

Tall Cabinet Depth is 12" or 24".

Vanity Cabinet Depth is 18" or 21", Height 32" or 34 1/2".

CUT FOR GLASS SPECIALTY DOORS*

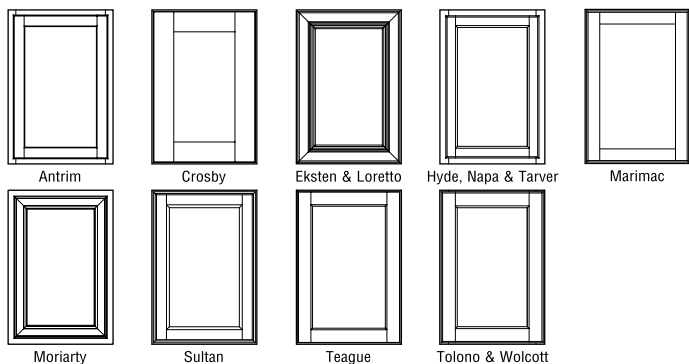

*Glass not included, but available to order separately.

MULLION SPECIALTY DOORS*

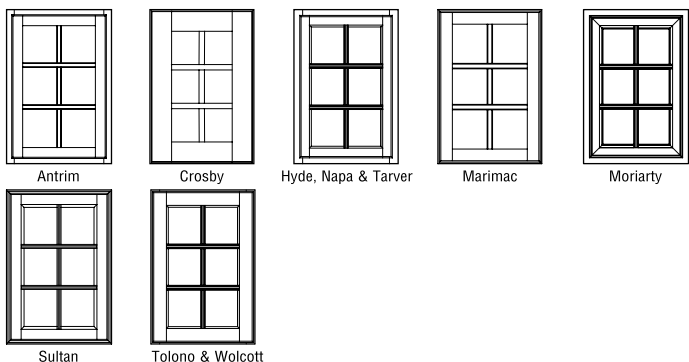

*Glass not included, but available to order separately.

WALL SINGLE DOORS

A Wall Single Door	W9** L or R	W15** L or R	W21** L or R
B Wall Top Hinge Single Door	W12** L or R	W18** L or R	W24** L or R
		WTH30**	WTH36**

WALL DOUBLE DOORS

A Wall Double Door	W21**	W30**	W39**	W48**
	W24**	W33**	W42**	
	W27**	W36**	W45**	

WALL REFRIGERATOR OPTIONS

A Wall Refrigerator			W****24
B Wall Top Hinge Refrigerator Single Door		WTH30**24	WTH36**24
C Wall Refrigerator w/Shelf		W**2424	W**2724

WALL THREE DRAWER

A Wall Three Drawer Single Door	W3D15** L or R	W3D18** L or R	W3D24** L or R
B Wall Three Drawer Double Door			W3D24**

TIP: Great for plastics container storage. Store bowls above and organize lids in drawers below.

WALL CORNER OPTIONS

A Wall Corner		WC**** L or R
B Easy Reach Wall Corner		ER** L or R

DIAGONAL WALL CABINETS

A Diagonal Wall		DW***** L or R
B Diagonal Wall w/Lazy Susan		DW**2424LS L or R
	w/Plywood Lazy Susan	DW**2424S L or R

WALL END OPTIONS

A Wall End Cabinet				WEC12** L or R
B Wall Transition Cabinet				WTC1230**
				WTC1236**
				WTC1239**
				WTC1242**
C Wall Message Center				WMC12** L or R
D Wall Quarter Round End Shelves, Square Top & Bottom Panels				WQRES6**STSB

WALL AND BASE STORAGE

WALL MICROWAVE CABINETS

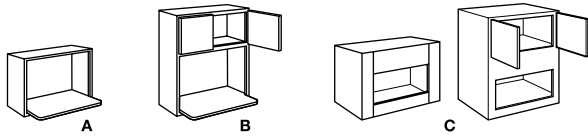

A Wall Microwave Cabinet		MW**18
B Wall Microwave Double Door Cabinet		MW**36
C Wall Built-In Microwave Cabinet	WBMW24**** WBMW27****	WBMW30****

WALL SPICE RACKS/ORGANIZERS

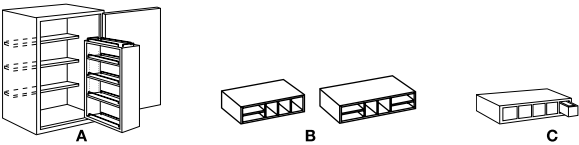

A Wall Spice Rack Cabinet	WSR18** L or R	WSR21** L or R
B Wall Organizer		WO**
C Wall Spice Drawer		WSD**

WALL APPLIANCE GARAGE/CORNER DOOR

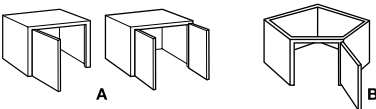

A Wall Appliance Garage	WAGD24 L or R	WAGD24
B Corner Door		CD**** L or R

WALL/BASE PULLOUT STORAGE

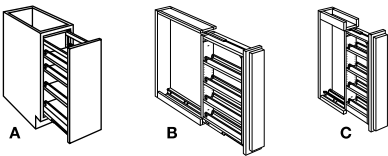

A Base Pantry Pullout		BPP**
B Base Box Column Pullout w/Overlay		BBCPO*OL
C Wall Box Column Pullout w/Overlay		WBCPO*30OL

WALL CHINA & WINE CABINETS

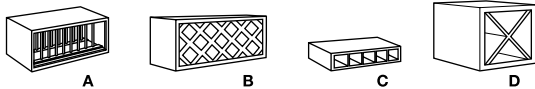

A Wall China Display		WCD**15
B Wall Wine Rack		WNR****
C Wall Wine Cubby		W6**
D Wine Storage Cabinet		WSC1818**

RACKS & SHELVES

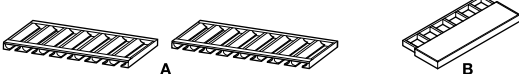

A Wine Glass Holder		WGH**
B Floating Shelves		FS**

WALL WOOD HOODS*

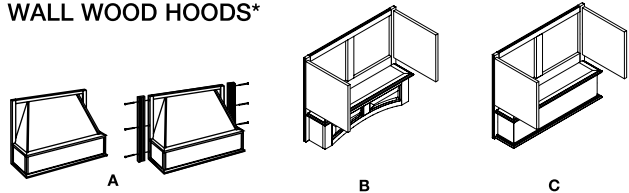

A Tapered Wood Hood		TWH**
B Wood Hood Canopy Arched		WHCA**
C Wood Hood Canopy Square		WHCS**

BASE SHELF CABINETS

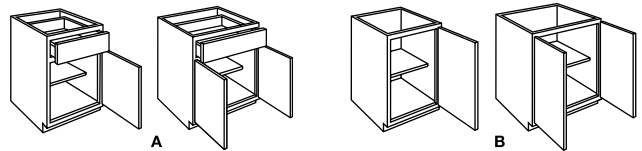

A Base Cabinet	B** L or R	B**
B Full Height Base Cabinet	B**FH L or R	B**FH

BASE POTS, PANS, & BAKING DISHES CABINETS

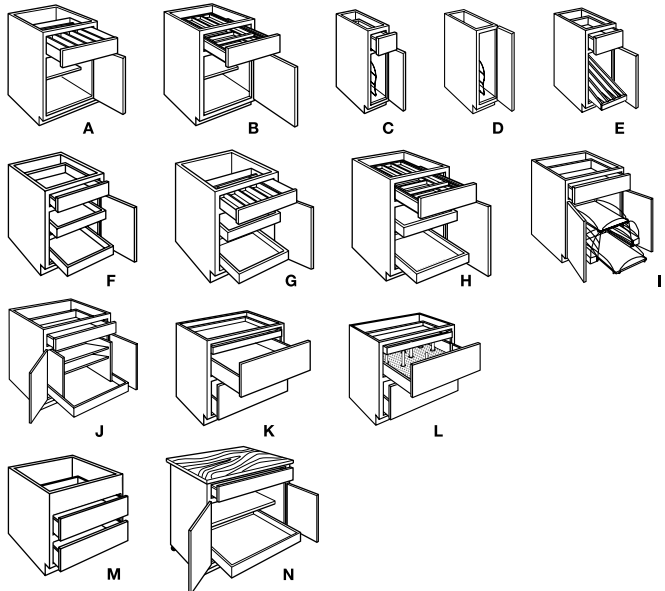

A Base w/Cutlery Insert Wood Organizer	B**CIW L or R	B24CIW
B Base w/Wood Tiered Cutlery Divider Drawer	B**WTCD L or R	B24WTCD
C Base w/Tray Divider		TD** L or R
D Base Full Height Door w/Tray Divider		TD**FH L or R
E Base w/Roll-Out Tray Divider		B**TDRO L or R
F Base w/Roll Trays	B**RT L or R	B**RT
(Accommodates up to 2 extra roll trays.*)		
G Base w/Cutlery Insert Wood Organizer and Roll Trays	B**RTCW L or R	B24RTCW
(Accommodates up to 2 extra roll trays.*)		
H Base w/Wood Tiered Cutlery Divider Drawer and Roll Trays	B**RTWTC L or R	B24RTWTC
I Base Pots and Pans Pull-Out	BPPP24 L or R	BPPP24
J Pots & Pans Organizer Base w/Drawer	B24PS L or R	B**PS
K Two Drawer Base w/Roll Tray		2DB**RT
L Two Drawer Base w/Roll Tray and Pegged Dish Organizer		2DB36RTPDO
M Two Drawer Base, Drop-in Range		2DB36DR
N Floating Island Base		FIC**

*Order extra roll trays separately.

BASE SUPERCABINET™

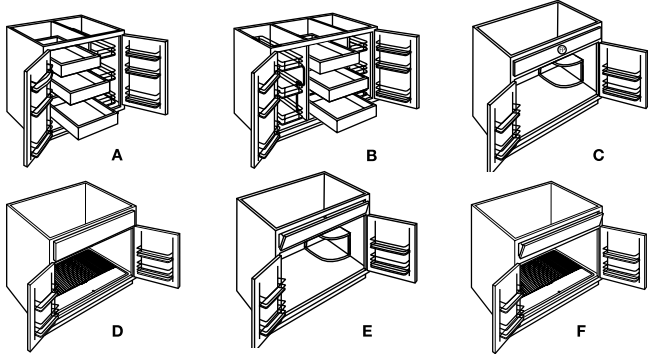

A 30" SuperCabinet™	BSC30RP
B 36" SuperCabinet™	BSC36PRP
C Sink Base SuperCabinet™	SB36S
D Sink Base SuperCabinet™ w/CabMat™	SB36SCM
E Sink Base SuperCabinet™ w/Tilt Downs	SB36STS
F Sink Base SuperCabinet™ w/Tilt Downs and CabMat™	SB36STSCM

SINK BASES

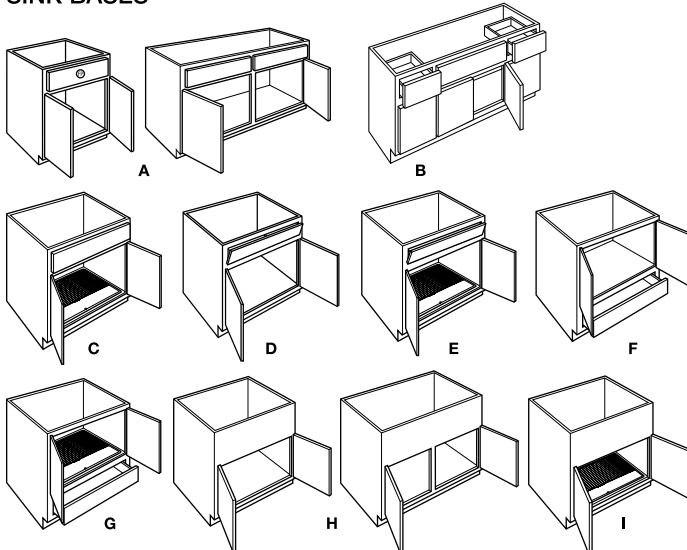

A Sink Base	SB24 L or R	SB**
B Sink Base w/Drawers		2SBD**
C Sink Base w/CabMat™		SB**CM
D Sink Base w/Tilt Downs		SB**ST
E Sink Base w/Tilt Downs and CabMat™		SB**STCM
F Sink Base w/Drawer Below		SB36D
G Sink Base w/Drawer Below and CabMat™		SB36DCM
H Country Sink Base		CNTYSB**
I Country Sink Base w/CabMat™		CNTYSB**CM

CORNER SINK BASES

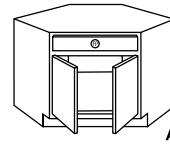

A Angled Corner Sink Base	ACS** L or R	ACS42
----------------------------------	--------------	-------

BASE CORNER OPTIONS

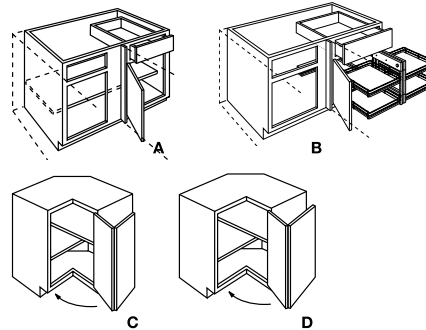

A Base Corner	BC** L or R
B Base Corner w/Pullout	BC**PO L or R
C Base Easy Reach	BER36 L or R
D Asymmetrical Base Easy Reach	BER**** L or R

BASE LAZY SUSANS

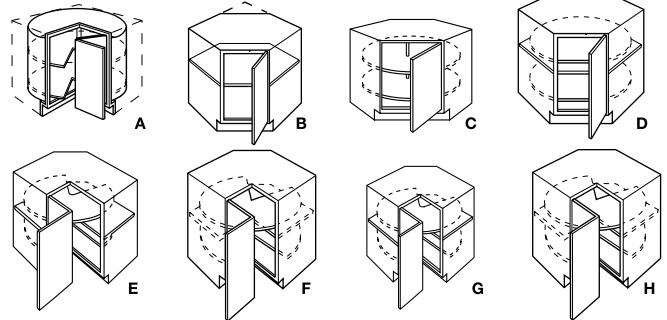

A Base Lazy Susan Corner w/Full Height Center Hinged Door	BLS36 L or R
B Diagonal Base w/Full Height Door	DAB36FS L or R
C Diagonal Base w/Full Height Door and Lazy Susan	DAB36S L or R
D Diagonal Base w/Full Height Door and Super Lazy Susan	DAB36SLS L or R
E Asymmetrical Super Lazy Susan	SLS**** L or R
F Asymmetrical Solid Wood Super Lazy Susan	SLSW**** L or R
G Super Lazy Susan	SLS** L or R
H Solid Wood Super Lazy Susan	SLSW** L or R

BASE END OPTIONS

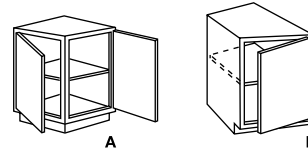

A Base End Cabinet	BEC24
B Base Transition Cabinet	BTC12**

BASE AND TALL STORAGE

DRAWER BASE CABINETS

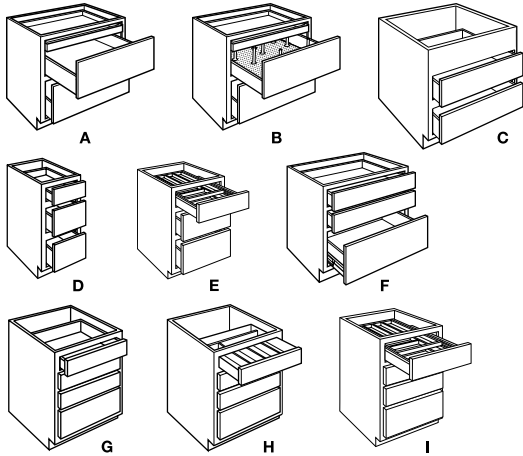

A Two Drawer Base w/Roll Tray	2DB**RT
B Two Drawer Base w/Roll Tray and Pegged Dish Organizer	2DB36RTPDO
C Two Drawer Base, Drop-In Range	2DB36DR
D Three Drawer Base	3DB**
E Three Drawer Base w/Wood Tiered Cutlery Divider Drawer	3DB**WTCD
F Three Drawer Base w/Deep Drawer	3DB**DD
G Four Drawer Base	4DB**
H Four Drawer Base w/Cutlery Insert Wood Organizer	4DB**CIW
I Four Drawer Base w/Wood Tiered Cutlery Divider Drawer	4DB**WTCD

BASE WASTE CABINETS

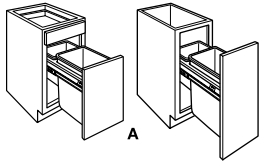

A Base Wastebasket w/Full Height Door	BWB**
	BWB**FH

BASE END OPTIONS

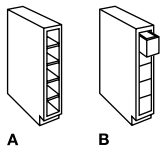

A Base Wine Cubby (Holds 5 bottles.)	BWC6
B Base Spice Cabinet w/Drawers	BSD6

BASE OVEN & MICROWAVE CABINETS

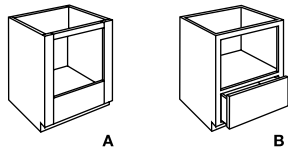

A Base Oven Cabinet	B0**
B Base Microwave Cabinet w/Drawer	BMWD**34

BASE CORNER PENINSULA OPTIONS

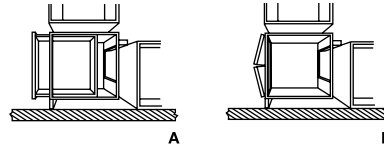

A Base Corner Peninsula w/Shelf and Drawer	BCP24
B Base Corner Peninsula w/Shelf and Full Height Doors	BCP24FH

TALL UTILITY CABINETS

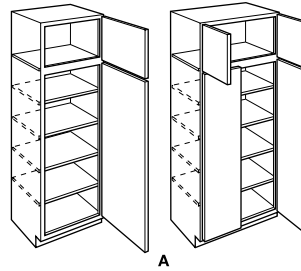

A Utility Cabinets	U***** L or R	U*****
---------------------------	---------------	--------

UTILITIES WITH ROLL TRAYS / UTILITY ORGANIZER

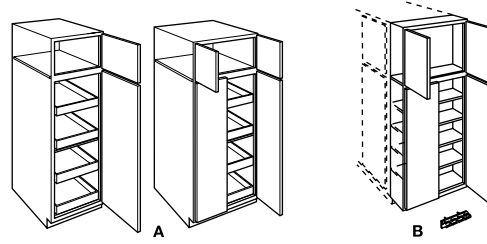

A Utility w/Roll Trays	U15**24RT L or R	U24**24RT L or R	U30**24RT
	U18**24RT L or R	U24**24RT	U36**24RT
	U21**24RT L or R		
B Utility Organizer Cabinet			UOC24**6

TALL OVEN & MICROWAVE CABINETS

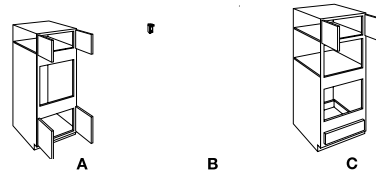

A Single Oven Cabinet	OCS****24
B Double Oven Cabinet	OCD****24
C Oven Microwave Cabinet	OMC****24

WALL BOOKCASES WITH VALANCE

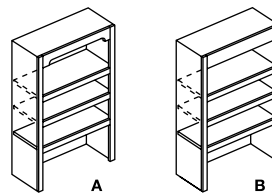

Specify valance type by adding appropriate letters to end of model number.	A with Furniture Valance	B with Straight Valance
Wall Bookcase w/Valance	W****BC	FV VV

OFFICE AND VANITY STORAGE

TALL BOOKCASES WITH VALANCE

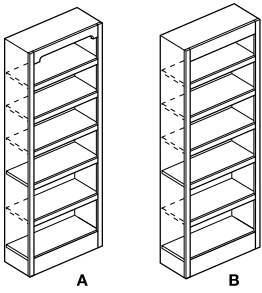

Specify valance type by adding appropriate letters to end of model number.	A with Furniture Valance	B with Straight Valance
Tall Bookcase w/Valance	T***12BC FV	VV

BASE OFFICE FURNITURE

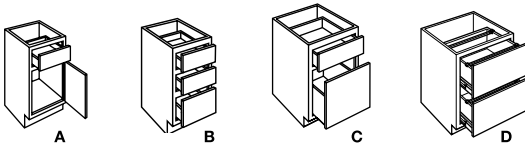

A Desk Door Drawer Base	DDO**29** L or R	DDO**29**
B Desk Drawer Base	DDR**2921	DDR**2924
C Desk File Drawer Base	DFD**2921	DFD**2924
D Desk Double File Drawer Base	DDFD2429**	DDFD3029**

FURNITURE DRAWERS & WOOD TOPS

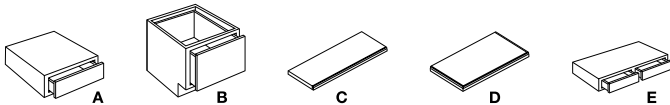

A Furniture Drawers	FD**0624	FD**1224
B Furniture Drawer Window Bench		FDWB**1824
C Wood Tops, One Sided	1TWT7221	1TWT7224
D Wood Tops, Three Sided	3TWT**21	3TWT**24
E Under Counter Drawer		UCD**21

VANITY SINK BASES

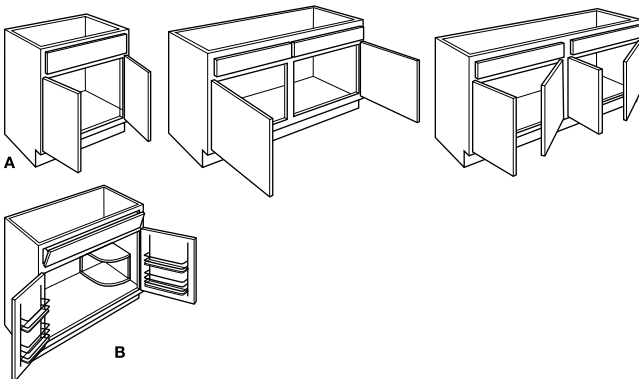

A Vanity Sink Base w/False Panels	VSB24**** L or R	VSB****18 VSB****21
B Vanity Sink Base SuperCabinet™ w/Tilt Downs		VSSB**3421ST

VANITY DRAWER BASE CABINETS

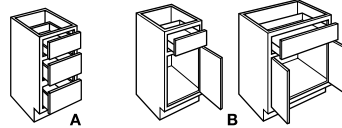

A Vanity Drawer Base		VDB****21
B Vanity Base w/Drawer	VB****21 L or R	VB****21

VANITY PULLOUT

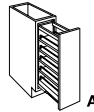

A Vanity Pullout	VP93421
-------------------------	---------

VANITY SINK DRAWER BASES

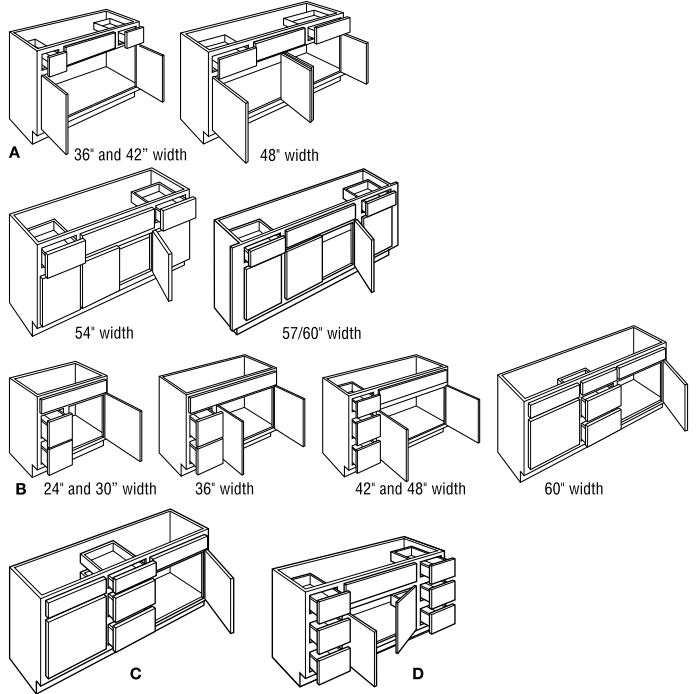

A Vanity Sink Drawer Base	2VSD****21	2VSD54**21FP 2VSD57/60**21FP
B Vanity Sink Drawer Base w/False Panels	VSD*****FP L or R	VSD60**21FP
C Vanity Sink Three Drawer Base	VS3D54**21	VS3D60**21
D Vanity Sink Drawer Base w/Six Drawers & False Panel		6VSD****21FP

LINEN CLOSETS & VANITY UTILITY

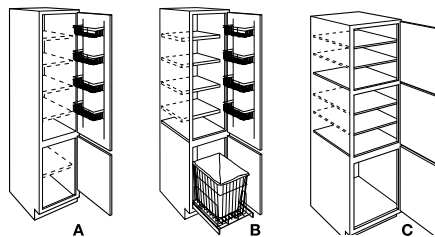

A Linen Closet	LC188421 L or R
B Linen Closet w/Removable Hamper	LCRH188421 L or R
C Vanity Utility	VU188421 L or R

WALL CABINETS, VANITY MIRROR, & MEDICINE CABINET

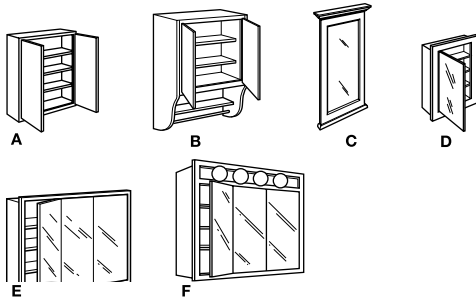

A Vanity Wall Cabinet	W24306
B Vanity Wall Towel Bar	VWTB24
C Vanity Mirror	VM**35
D Single Door Medicine Cabinet	MC16
E Tri-View Medicine Cabinet	TV**
F Tri-View Medicine Cabinet Lighted w/Chrome Face Plate	TMLC****

PLAIN FILLERS

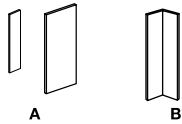

A Filler	F***	TF***	TF**FH
B Corner Filler			CF330

OVERLAY FILLERS

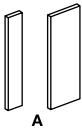

A Overlay Filler	OL***	VOL***
-------------------------	-------	--------

ORNATE FILLERS

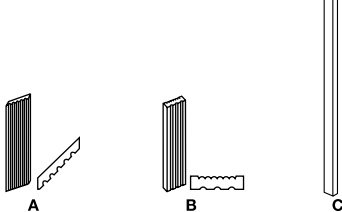

A Angled Fluted/Plain Reversible 3" Filler	BLVDFF**	BLVDTF96
B Fluted/Beaded Reversible 3" or 6" Filler	FBF***	TFBF*96
C Space Filler		S66X1*

BOX COLUMN FILLERS

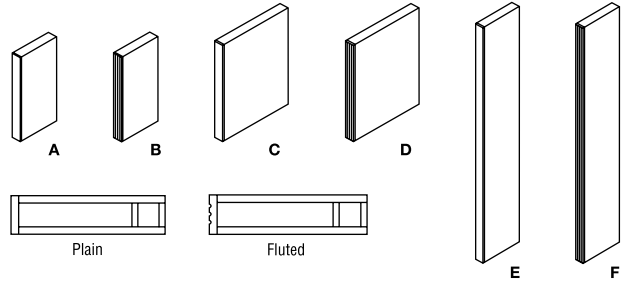

A Wall Plain	W***BCFP	
B Wall Fluted	W***BCFF	
C Base Plain	B334.527BCFP	
D Base Fluted	B334.527BCFF	
E Tall Plain	T3**15BCFP	T3**27BCFP
F Tall Fluted	T3**15BCFF	T3**27BCFF

DECORATIVE APPLIANCE PANELS

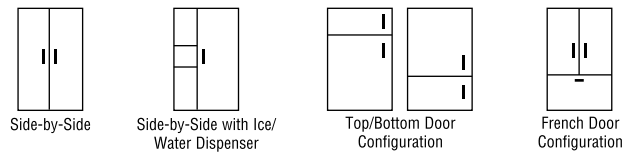

NOTE: Please see designer for complete listing of availability and sizes for customizable decorative appliance panels.

A Custom Panels	DAPNL1/4	DAPNL3/4	DAPNL3/4APF
------------------------	----------	----------	-------------

PANELS & SKINS

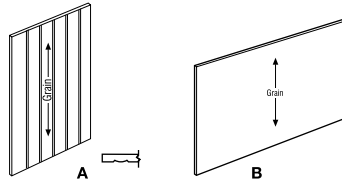

A Wood V-Grooved Panel Skin	BP4834.5VG	BP4896VG
B Cross Grain Veneer Back Panel Skin	BP9634.5CRSGR	BP9648CRSGR

PANELS W/FILLER ATTACHED

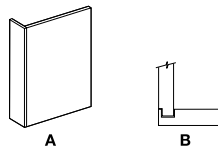

A Panels w/Filler Attached	BEPF1.5LAM	TEP24**F1.5LAM
	BEPF1.5WD	TEP24**F1.5WD
	BEPF3LAM	TEP24**F3LAM
	BEPF3WD	TEP24**F3WD
B Panels w/Filler Attached & Furniture Ends	BEPF1.5FPE	TEP24**F1.5FPE
	BEPF3FPE	TEP24**F3FPE

CROWN MOULDINGS

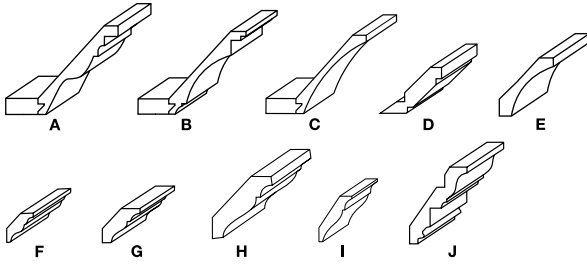

A Classic Tall Crown	CLTCROWN
B Cornice Tall Crown	COTCROWN
C Cove Crown	COVECROWN
D Shaker Crown	SHKRCRM8
E Small Cove Crown Moulding	SMCOVECROWN
F Small Crown	SCM8
G Solid Wood Crown	SWCRM8
H Solid Wood Large Crown	SWLCRM8
I Solid Wood Tall Crown	SWTCRM8
J Solid Wood Victorian Crown	SWVCRM8

MOULDING INSERTS

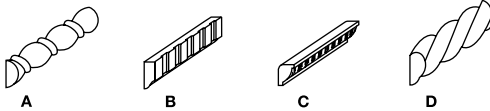

A Braided	BRAIDM
B Dentil	DE8
C Egg & Dart	EGD8
D Rope	RPM8

ACCENT MOULDINGS

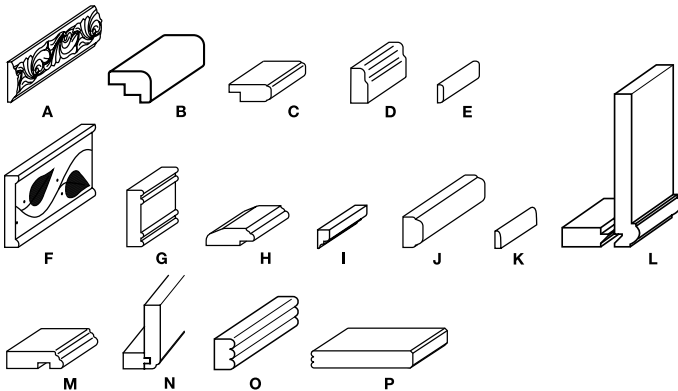

A Acanthus	ACAM
B Back Panel Moulding	BPM8
C Cabinet Panel Edge	CPE8
D Countertop Edge-Traditional	TCM8
E Flat Scribe	SM8
F Ivy	IVYM
G Library	LBRM
H Mirror Frame	WMF8
I Ogee Edge	OGEEM
J Single Bead Edge	SBE8
K Small Scribe	SSM
L Soffit Filler Moulding	SFM8
M Soffit Trim	TSTM
N Starter Moulding	STR8
O Triple Bead Edge	TBEM
P Triple Bead Pilaster	TBP8

TOE MOULDINGS

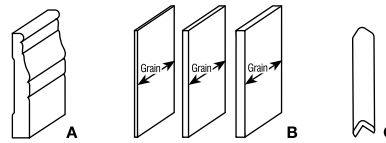

A Baseboard		BBM8
B Toeboard	TB8WD14	TB8LAM**
C Toekick Cap		TKC

WINDOW CASINGS



A Window Casing-Traditional	WCT*
------------------------------------	------

LIGHT RAILS

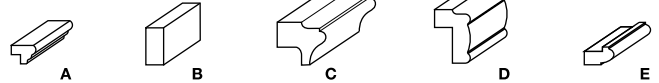

A Cap Moulding	CAPM
B Light Baffle-Square	LB2
C Small Light Rail Moulding	SMLR
D Light Rail Moulding	LRM
E Valley Forge Moulding	VFR8

CORNER MOULDINGS

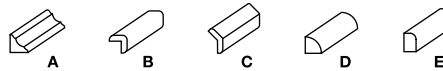

A Inside Corner	ICM8
B Outside Corner	OCM8
C Outside Corner 135°	OC135
D Quarter Round	ORM
E Shoe-Convex Inside Corner	SHM8

VALANCES

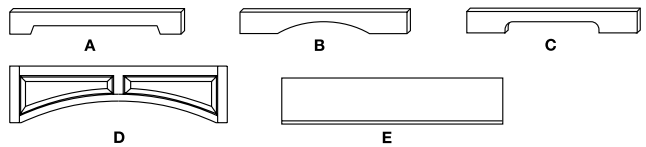

A Angled Furniture Toekick Valance	AVTOE**
B Arched Valance	AV**
C Furniture Valance	FV**
D Raised Panel Arch Valance	RPV**
E Straight Valance	VV**

DECORATIVE OVERLAYS

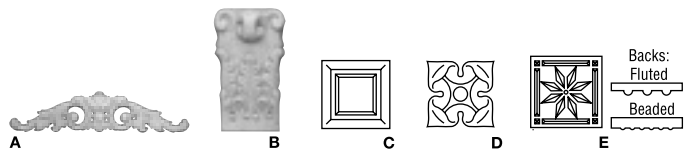

A Acanthus Overlay	ACOVLY
B Acanthus Ornament	ACO
C Mission Rosette	ROSETTEMIS
D Scroll Rosette	ROSETTESCR
E Corner Rosette-Fluted Beaded	FFRC3X3 BFRC3X3

DECORATIVE SUPPORTS

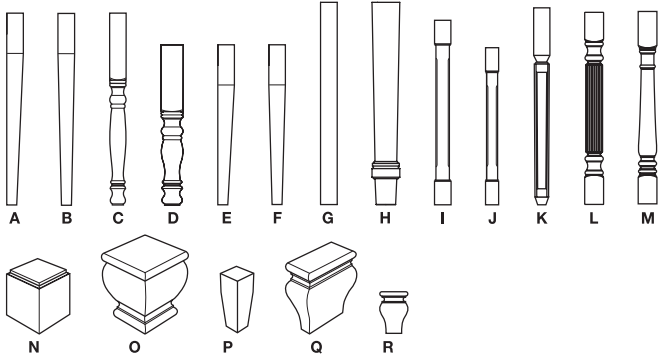

A Bar Leg, 2-Sided	2SBARLEG
B Bar Leg, 4-Sided	4SBARLEG
C English Bar Column	ENGBARCOLUMN
D English Island Column	ENGISLCOLUMN
E Island Leg, 2-Sided	2SISLLEG
F Island Leg, 4-Sided	4SISLLEG
G Island Leg Straight	ISLEGST
H Island Leg Tapered	ISLEGTPRD
I Metro Bar Column	METBARCOLUMN
J Metro Island Column	METISLCOLUMN
K Mission Leg	DLEGMISSION
L Reed Leg	RDLEG
M Spool Leg	SPLEG
N Large Square Foot	LGSQFOOT
O Lillie Foot	LIFOOT
P Tapered Leg	TAPLG
Q Toekick Tulip Foot	TKTLFOOT
R Tulip Foot	TLFOOT

DECORATIVE SPLIT TURNINGS

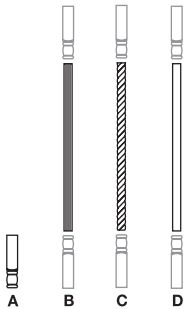

A End Split Turning	SPRINGEND
B Reed Split Turning**	SPRINGREED**
C Rope Split Turning	SPRINGROPE**
D Spool Split Turning	SPRINGSPPOOL**

DECORATIVE CORBELS & SHELF SUPPORTS

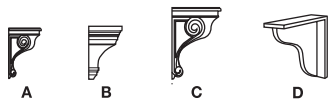

A 9" Small Corbel	SMCORBEL
B 9" Art Corbel	CORBELART9
C 13" Large Corbel	LGCORBEL
D Snack Bar Support	SBS

WALL ACCESSORIES



A Cookbook Rack	CBR
------------------------	-----

BASE / TALL / VANITY ACCESSORIES

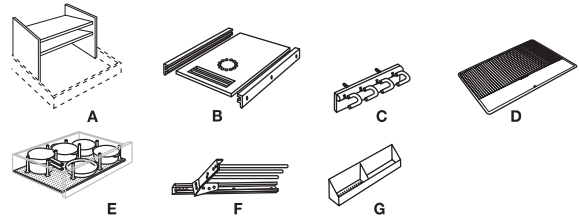

A Base Pan Storage	BPS**
B Bread Box Lid	BBX**
C Broom Clip	BRMCLP
D CabMat™	CABMAT**
E Pegged Dish Organizer	PDO
F Sliding Towel Rack	STR
G Tilt Out Tray	TOT**

BASE CUTLERY, ORGANIZERS, & DIVIDERS

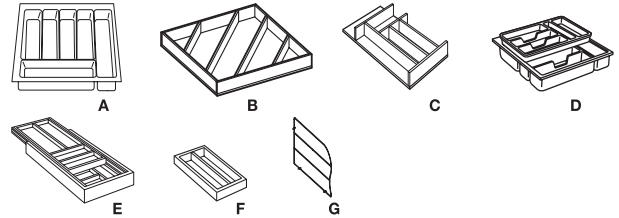

A Cutlery Divider	CI**
B Cooking Utensil Divider	CUDD**
C Cutlery Insert Wood Organizer	CIW**
D Cutlery Divider, Tiered	TCD**
E Wood Tiered Cutlery Divider Drawer	WTCD**
F Lid Organizer	LO
G Tray Divider Kit	CTDK

ROLL TRAY KITS & SHELVES

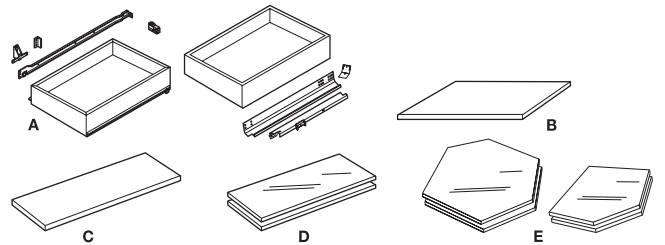

A Roll Tray Kits	RT**	RT**SP
B Exterior Shelf	ES****	ES****APF
C Full Depth Shelves	SK9**	SK****
D Glass Shelf Kit		GSK****
E Glass Shelf Kit, Diagonal		GSKDW**



Product photography and illustrations have been reproduced as accurately as printing technologies permit. To ensure highest satisfaction, we strongly suggest you view an actual sample for best color, wood grain and finish representation.

KEMPER[®]
echo[™]



LOOKING FOR MORE KEMPER[®]?

Kemper Echo is a unique line brought to you by Kemper Cabinetry. For over 45 years, Kemper has offered more designer-inspired colors and styles; more wood grain and laminate options; and, more modernly engineered conveniences that capture the visual and practical vibe of the times. With every inch of meticulous workmanship backed by a limited lifetime warranty. To get a feel for our full product selection, visit www.kempercabinets.com.